

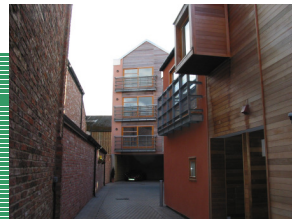

City of York

Interim Planning Statement On Sustainable Design and Construction

Approved by Planning Committee on 22nd November 2007 for the purposes of Development Control



City of York Council

Interim Planning Statement on Sustainable Design and Construction

November 2007

Copyright City of York Council 2007

Overview

It is the Council's objective to achieve development that has a low or positive environmental impact. A key part of achieving this is to require developers to consider sustainable design and construction issues as part of all new development, and proposals to change existing developments. This Interim Planning Statement (IPS) sets out what is expected from applicants and outlines standards for achieving sustainable design and construction in all types of large and small scale, residential and non-residential development including conversions and domestic extensions.

This IPS went out for a period of public consultation over the course of three months from February to May 2007. As part of preparing this statement the Council sought public views on a draft statement (formally know as a draft Supplementary Planning Guidance - SPG). Following this period of consultation the Council considered all comments received and made the necessary changes to the document. This IPS was formally approved at planning committee, and will be a material consideration in determining all planning applications.

If you would like to speak to an officer about this IPS you can write, phone or email using the details below:

Write: City Development Team / Planning and Design Team
City of York Council
9 St Leonard's Place
York
YO1 7ET

E-mail: citydevelopment@york.gov.uk

Tel: 01904 551666 (Sustainability Officer) or 551466 (City Development)

Additional copies of this document are available upon request, or alternatively can be downloaded on our website for free at: www.york.gov.uk

Please contact us if you would like this information in an accessible format (for example, large print or by email) or another language.

This information can be provided in your own language.

我們也用您們的語言提供這個信息 (Cantonese)

এই তথ্য আপনার নিজের ভাষায় দেয়া যেতে পারে। (Bengali)

Ta informacja może być dostarczona w twoim własnym języku. (Polish)

Bu bilgiyi kendi dilinizde almanız mümkündür. (Turkish)

یہ معلومات آپ کی اپنی زبان (بولی) میں بھی مہیا کی جاسکتی ہیں۔ (Urdu)

 (01904) 551550

Contents

Section 1: Introduction	5
Introduction	5
Policy Overview	5
Policy GP4a	6
How to use this document	7
What will be expected from applicants?	8
Section 2: Large Scale Commercial Developments	9
BREEAM Assessment	9
Community Involvement and the Local Economy	10
Pollution and Site Management	10
Renewable Energy	13
Refurbishments, Conversions and Changes of Use	13
Section 3: Small Scale Commercial Developments	14
Accessibility	15
Community Involvement and the Local Economy	15
Design	16
Resources	17
Pollution and Site Management	18
Landscape and Wildlife	19
Renewable Energy	21
Recycling	21
Refurbishments, Conversions and Changes of Use	21
Section 4: Residential Developments	23
Code for Sustainable Homes	24
Resources	24
Renewable Energy	24
Recycling	25
Section 5: Development of Existing Residential Dwelling Units (of 5 dwellings and above)	27
Pollution and Site Management	27
Renewable Energy	29
Recycling	30
Section 6: Development of Existing Residential Dwelling Units (of 4 dwellings and below)	32
Resources	32
Pollution and Site Management	33
Renewable Energy	34
Recycling	35
Section 7: Domestic Extensions	37
Accessibility	38
Community Involvement and the Local Economy	38
Design	38
Resources	39
Pollution and Site Management	39
Landscape and Wildlife	40
Renewable Energy	40
Recycling	41
Appendices	43
Appendix 1: BREEAM Overview	43
Appendix 2: Further Advice	45
Appendix 3: Best Practice	49
Appendix 4: The Code for Sustainable Homes	51
Appendix 5: Recycling	53

1. Introduction

- 1.1 This Interim Planning Statement (IPS) supports policy GP4a (as set out in Figure 1) of the City of York Draft Local Plan Incorporating the 4th set of changes (Approved April 2005). It provides guidance to applicants on preparing a sustainability statement as required in the policy. The level of detail required in the statement will be dependent on the size and type of development proposed.
- 1.2 It is the Council's objective to achieve development that has a favourable environmental impact whilst maximising social, economic and environmental gains. This means encouraging positive and long term thinking when making decisions and taking account of a wide range of costs and benefits, including those which cannot be easily valued in monetary terms. The requirement under Policy GP4a for developers to submit a sustainability statement is a key part of ensuring these issues are considered as part of new development. The information stated within this document reflects national and regional guidance and therefore should be met. It is for the applicant to explain how they will meet the requirements and if this is not possible to justify why not, to the satisfaction of the Local Planning Authority (LPA).

Policy Overview

- 1.3 According to the Brundtland Commission 1982, sustainable development is widely known as:

'development that meets the needs of the present without compromising the ability of future generations to meet their own needs.'

- 1.4 The principle of sustainable development underpins many international and national policies – from The Kyoto Protocol on climate change to Planning Policy Statement 22: Renewable Energy (PPS22). The UK Government published an updated Sustainable Development Strategy, 'Securing the Future' in March 2005. The Strategy outlines that the goal of sustainable development is to be pursued in an integrated way through a sustainable, innovative and productive economy that delivers high levels of employment and a just society that promotes social inclusion, sustainable communities and personal well-being. These wide ranging economic and social aims are to be progressed alongside protecting and enhancing the physical and natural environment and using resources and energy as efficiently as possible. This approach is reflected in the emerging Regional Spatial Strategy for Yorkshire and the Humber. In addition, the York City Vision & Community Strategy 2004 – 2024 states that the Council must seek a progressive reduction of York's Ecological Footprint to 3.5 hectares per person by 2033 and by 70% over the next 50 years. For more information visit www.york.gov.uk/environment/Sustainability/Agenda21/Ecological_footprint/
- 1.5 An overarching aim of the City of York Development Control Local Plan (2005), is to achieve sustainable design and construction. Policy GP4a, as set out in Figure 1, introduces ten criteria that cover a wide spectrum of environmental, social and economic issues that will be used to judge the sustainability of a proposal.

Figure 1: Policy GP4a (Sustainability)

Proposals for all development should have regard to the principles of sustainable development as summarised in criteria a- i below.

All commercial and residential developments will be required to be accompanied by a sustainability statement. The document should describe how the proposal fits with the criteria listed below and will be judged on its suitability in these terms.

Development should:

- a) provide details setting out the accessibility of the site by means other than the car and, where the type and size of the development requires, be within 400m walk of a frequent public transport route and easily accessible for pedestrians and cyclists;
- b) contribute toward meeting the social needs of communities within the City of York (including housing, community and recreational facilities, car clubs, recycling facilities and communal laundry blocks) and to safe and socially inclusive environments;
- c) maintain or increase the economic prosperity and diversity of the City of York, and maximise employment opportunities (including supporting local goods and services and providing training and employment for local unemployed and young people);
- d) be of a high quality design, with the aim of conserving and enhancing the local character, heritage and distinctiveness of the City;
- e) minimise the use of non-renewable resources, re-use materials already on the development site, and seek to make use of grey water systems both during construction and throughout the use of the development. Any waste generated through the development should be managed safely, recycled and/or reused. The 'whole life' costs of materials should be considered;
- f) minimise pollution, including that relating to air, water, land, light and noise;
- g) conserve and enhance natural areas and landscape features, provide both formal and informal open space, wildlife areas and room for trees to reach full growth;
- h) maximise the use of renewable resources on development sites and seek to make use of renewable energy sources, such as heat exchangers and photovoltaic cells; and
- i) make adequate provision for the storage and collection of refuse and recycling.

What will be expected from applicants?

- 1.6 As stated in policy GP4a, all developments will be required to submit a sustainability statement, which describes how the proposal fits with the criteria listed in the policy. For domestic extensions, sustainability statements can be submitted in the form of a questionnaire (see page 37 of the document for more details). This IPS will be a material consideration in determining all planning applications. Therefore it is in the applicants best interest to use this guidance, and if necessary consult on the proposals with the Council at an early stage.
- 1.7 The level of detail required in the sustainability statement will be dependent on the type and size of development proposed. Therefore, for the purposes of this IPS, development has been split into six main types (see below). The specific guidance for different types of development is identified on the diagram over the page.
- **Large scale commercial development:** development over 500m² and over for commercial development; see page 9
 - **Small scale commercial development:** developments of less than 500m² for commercial development; see page 14
 - **Residential Development:** New build of 1 dwelling unit and above; see page 23
 - **Development of Existing Residential Dwelling Units** (of 5 dwellings and above); see page 27
 - **Development of Existing Residential Dwelling Units** (of 4 dwellings and below); see page 32
 - **Domestic extensions:** extensions to existing residential dwellings; see page 37

How to use this Interim Planning Statement:

My Proposal is...

Commercial

Residential

*



**LARGE SCALE
COMMERCIAL
DEVELOPMENT
(500M² and
Over)**

**SMALL SCALE
COMMERCIAL
DEVELOPMENT
(Less than
500M²)**

**RESIDENTIAL
DEVELOPMENT
(1 dwelling unit
and above)**

**DOMESTIC
EXTENSIONS**



Section 2
See page 9

See Section
3
See page 14

New Build
Section 4
See page 23

Development of
existing
dwellings units
(5 and over)
Section 5
Page 27

Development of
existing
dwellings units
(4 and under)
Section 6
Page 32

Section 7
See page 37

* For mixed use developments consideration should be given to the floorspace. If 500m² or over, a BREEAM Bespoke assessment should be undertaken. If less than 500m², the small scale commercial and the residential sections should be observed and minimum standards met.

2. Large Scale Commercial Developments

For commercial development of 500m² and over.

- 2.1 Applicants proposing developments over the threshold of 500m² for commercial uses, will be required to submit a sustainability statement which addresses all of the criteria set out in policy GP4a. The sustainability statement should state that a BREEAM assessor have been appointed and give an indication of timescales. The statement should also explain how the minimum standards (recycled materials, waste and landfill, pollution, site management and renewable energy) stated at the end of this section, will be met.

BREEAM Standards

Minimum Standard: Applications for large-scale commercial developments will be expected to achieve an overall BREEAM standard rating of 'very good', this will need to be achieved at the Design and Procurement and Post Construction stages.

- 2.2 BREEAM is explained in more detail in Appendix 1. This will mean committing to achieve a BREEAM certification under an appropriate scheme at the detailed design stage. Applicants are advised to appoint a BREEAM assessor as soon as possible to ensure that the requirements are achieved. Further information on BREEAM and assessors can be found on www.bre.co.uk. Whilst the minimum standard required from developers is 'very good', developers are encouraged to meet a higher standard where possible and the Council will continue to review the standards in the future to take account of technological advances.

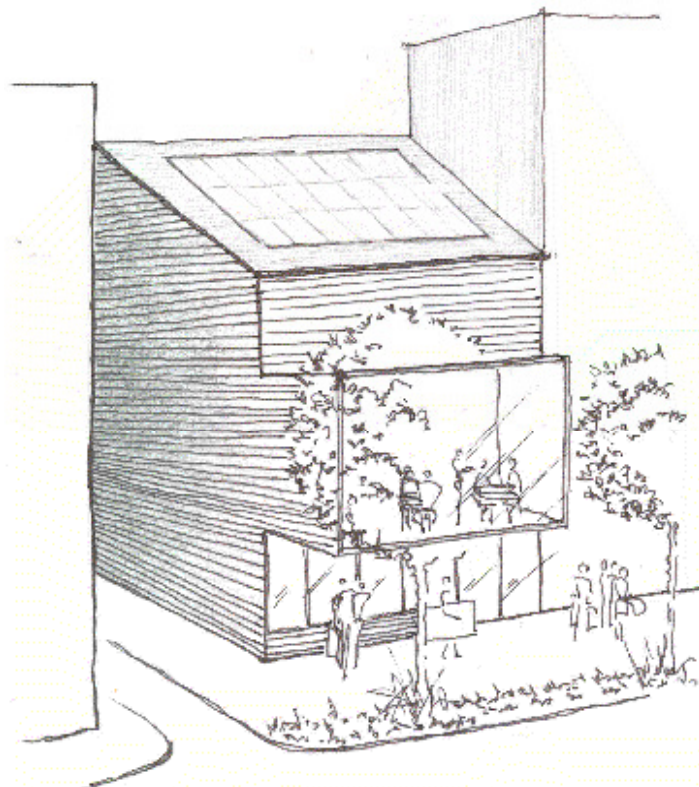

- 2.3 If the proposal is to be built in phases then the LPA will require a sustainability statement with the initial or outline application setting out principles, aims and commitments to achieve the requirements for the whole of the development. These requirements will be conditioned at the outline stage as reserved matters. As each phase comes forward for approval, a detailed sustainability statement would be required to ensure that the most up to date relevant standards are met.
- 2.4 In addition to a BREEAM assessment the following local minimum standards and questions that are not covered by BREEAM should also be satisfied:

Community Involvement and the Local Economy

- 2.5 The Council encourages community involvement at every opportunity and at the earliest stage of the development process. Early community involvement may help to overcome any objections that may arise at a later date. For more information please see our Statement of Community Involvement*, at www.york.gov.uk/environment/Planning/Local_development_framework/Statement_of_comm_involve/. The Council also encourages the use of locally sourced materials and provision of employment for local residents.
- 2.6 When addressing parts b) and c), of policy GP4a (see Figure 1) the following questions should be answered within the sustainability statement:
- In what way have you involved those communities/neighbours adjacent to the proposed development?
 - Will the proposed development use local labour during construction?
 - What percentage of materials used will be sourced locally (where available)?
 - Will the construction of the development provide any training opportunities for local people?

Pollution and Site Management:

Minimum Standard (Recycled Materials): All development requiring demolition of an existing building should include measures to maximise the reclamation of materials for recycling and reuse. For these developments, the sustainability statement must demonstrate a commitment to the implementation of the Institute of Civil Engineers (ICE) Demolition Protocol or equivalent.

- 2.7 Reducing the construction industry's demand for primary resources is vital to improving the sustainability of construction. The *Demolition Protocol* shows how the production of demolition material can be linked to its specification as a high

* The Statement of Community Involvement (SCI) sets out the Council's proposals for how the community will be involved, both in the production of planning documents, and through consultation on planning applications.

value material in new buildings. Further information is available on the Institute of Civil Engineers website www.ice.org.uk.

2.8 The protocol has 2 main components:

(i) Demolition Recovery Index:

The protocol shows how a building audit can be used to generate a *Demolition Recovery Index* (DRI). The DRI allows project teams to identify the potential for cost effectively recovering material from demolition. In addition, the DRI provides planning authorities with a tool for ensuring that demolition methodologies reflect national and local authority policies on waste management and sustainable development.

(ii) New Build Recovery Index:

The development of new standards, for example through the *Construction Products Directive*, means that the potential for specifying demolition recycle in new buildings is continually increasing. The protocol's New Build Recovery Index (NBRI) provides a tool for establishing the potential percentage and quantity of recovered materials that can be specified in a new building or other structure. Where a project involves demolition and new build, the NBRI can be linked to the DRI to provide project teams with a model for assessing the efficiency of resource use for the whole project.

Minimum Standard (Waste and Landfill): A Site Waste Management Plan must be submitted, and should be prepared in accordance with the DTI (Department of Trade and Industry) guidance on Site Waste Management Plans. For more information visit www.dti.gov.uk

The plan must include the following steps:

- 1) Assign responsibility to producing the plan;
- 2) Identify the types and quantities of waste;
- 3) Identify waste management options;
- 4) Identify waste management sites and contractors;
- 5) Carry out necessary training;
- 6) Plan for efficient materials and waste handling;
- 7) Monitor how much and what types of waste are produced;
- 8) Monitor and implement the plan;
- 9) Review how the plan worked at the end of the project.

2.9 Construction accounts for one-third of waste materials in the UK, including some 1.3 million tonnes of products that are delivered to site each year and not used. Analysis by leading firms in the construction industry shows that good practice in materials ordering and managing site waste can save up to 20% of materials on site. Together with financial savings from segregation and recycling wastes to avoid landfill, this can reduce build costs by 3%.

2.10 Applicants are reminded that recovered materials can be used as components in new construction. In particular, applicants should refer to the minimum standard

on the use of reclaimed/recycled materials in construction and the ICE Demolition Protocol outlined in paragraphs 2.8 above.

Minimum Standard (Pollution): The Sustainability Statement must:

- demonstrate the avoidance of materials that have used CFCs and HCFCs in their manufacture unless it can be shown that no alternatives are available;
- demonstrate that all timber and timber products used in the proposed development will be FSC accredited (or similar independent accreditation system for timber produced from sustainably managed forests); and
- demonstrate that lighting schemes are provided that are designed to reduce the occurrence of light pollution. Schemes will be expected to employ energy efficient lighting that also reduces light scatter. The council will normally accept proposals in line with the Institute of Lighting Engineers Guidance GNO1 2005.

2.11 Guidance on reducing light pollution has been prepared by the Institute of Lighting Engineers (ILE) who have produced a note on the reduction of obtrusive light GNO1, 2005. This provides good practice guidance and environmental designations in zones of 1 to 5, which designate area characteristics according to their use and lighting requirements. The zones range from the darkest areas in isolated rural sites to the lightest in a city centre with a lot of night time activity. Within these zones the guidance specifies the lighting installations that would be acceptable. In addition it provides curfew times in which appropriate light installations should be switched off, i.e. after 23:00hrs. It would be expected that applicants would follow these guidelines, identify the environmental zone in which the site lies and also undertake the actions suggested in the guidance. This information will need to be submitted as part of the sustainability statement.

Minimum Standard (Site Management): The applicant will be required to commit to achieving a level of performance equivalent to that required under the *Considerate Constructors Scheme*. The Council will expect this to be supported by a commitment to achieve certification under the *Considerate Constructors Scheme* unless the applicant can demonstrate why this cannot be achieved.

2.12 *The Considerate Constructors Scheme*, started in 1997, is a voluntary Code of Considerate Practice, which is adopted by participating construction companies, and everyone involved on the construction site. The scheme aims to improve the image of construction. The Code commits those contractors in the scheme to be considerate and good neighbours, as well as clean, respectful, safe, environmentally conscious, responsible and accountable. The scheme covers all construction activity within the UK, and is open to construction companies of all types and size. For more information visit:
www.considerateconstructorscheme.org.uk.

Renewable Energy:

Minimum Standard (Renewable Energy): The sustainability statement must demonstrate that at least 10% of the expected energy demand for the development will be provided for through on site renewable generation for heat and/or electricity. In addition parts of the development should be identified that could accommodate renewable energy installations in the future, for example the number/area of south facing roofs and potential wind turbine locations.

- 2.13 Renewable energy is the generation of heat, hot water or electricity from renewable resources such as the sun, wind and earth. Government grants are now available for many technologies and for different development types including commercial. More information can be found on the *Low Carbon Buildings Programme* website www.lowcarbonbuildings.org.uk. In order to qualify for a grant the development must first demonstrate energy efficiency and have planning consent for the technologies.

Refurbishments, Conversions, and Changes of Use

- 2.14 The reuse of existing buildings can be the most sustainable development option – many tonnes of resources and carbon emissions are locked up in our existing building stock. Their reuse and renovation saves resources and carbon emissions. However it must be recognised that the retention of some buildings is not the most sustainable long-term option due to their condition or inability to meet higher insulation standards. In some cases demolition and the reuse of materials may be the most sustainable option. It is for the applicant to justify the decision to demolish and new build as opposed to renovation in the submitted sustainability statement to the satisfaction of the Local Planning Authority.
- 2.15 Standard versions of BREEAM exist for common building types (i.e. courts, industrial, multi-residential, prisons, offices, retail and schools), and less common building types can be assessed against tailored criteria under the Bespoke BREEAM version.

Minimum Standard: Applications involving the reuse of large commercial buildings will be required to achieve an overall BREEAM standard rating of 'Very Good' for Design & Procurement Assessment and Post Construction Assessment stages.

- 2.16 For further information on BREEAM and how it will operate, please see Appendix 1. For further advice and best practice see Appendix 2 and 3.

3. Small Scale Commercial Developments

For commercial development of less than 500m².

- 3.1 Applicants proposing developments of less than 500m² for commercial uses, will be required to submit a sustainability statement which addresses all of the criteria set out in policy GP4a. Guidance on what is required with regard to each criteria is provided in the form of questions set out under each section below. The sustainability statement should answer all of the questions below and subsequently the relevant minimum standards (in carbon emissions and energy use, pollution, site management and renewable energy) will be met. It should be noted that a BREEAM assessment is **not** required for small scale developments.
- 3.2 Where practical and appropriate standards are identified to indicate what the Council expect developers to achieve as a minimum in new developments. In each case, the sustainability statement must set out the applicant's commitment to achieving the minimum standard and a description of how they are going to achieve it.

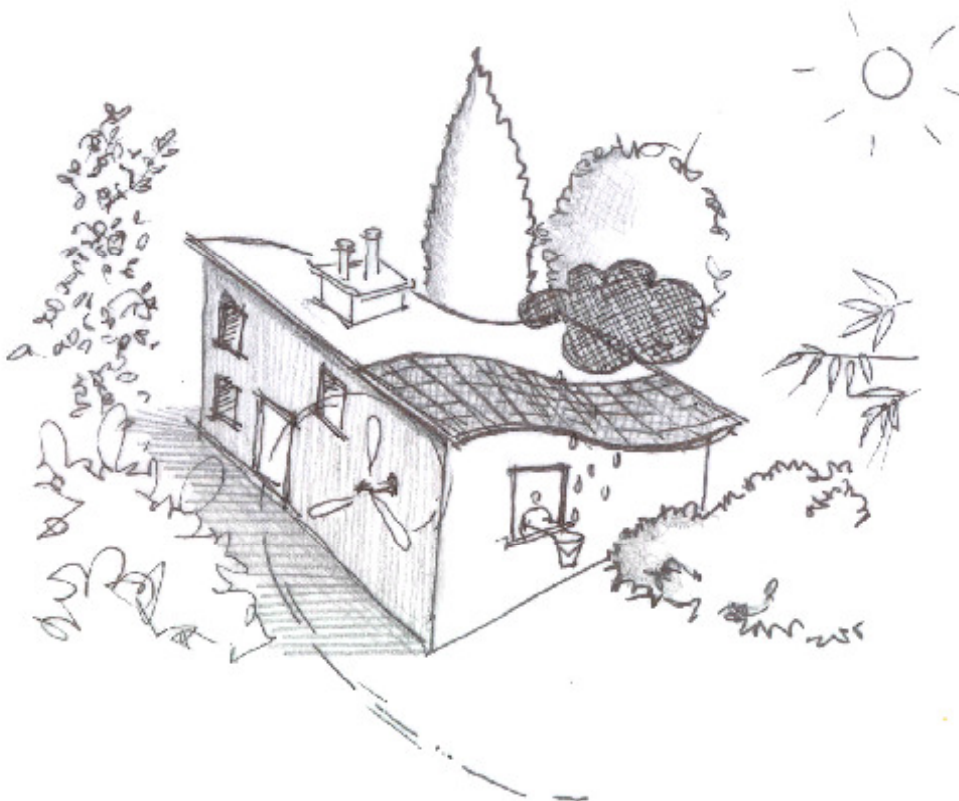

Accessibility:

Part a) of policy GP4a:

Development should provide details setting out the accessibility of the site by means other than the car and, where the type and size of development requires, be within 400m walk of a frequent public transport route and easily accessible for pedestrians and cyclists.

3.3 When addressing part a), the following questions should be answered:

- How does the proposal make provision for access to it by means other than the car?
- How close are the nearest public transport links?
- How does the proposal provide facilities for cyclists and pedestrians?

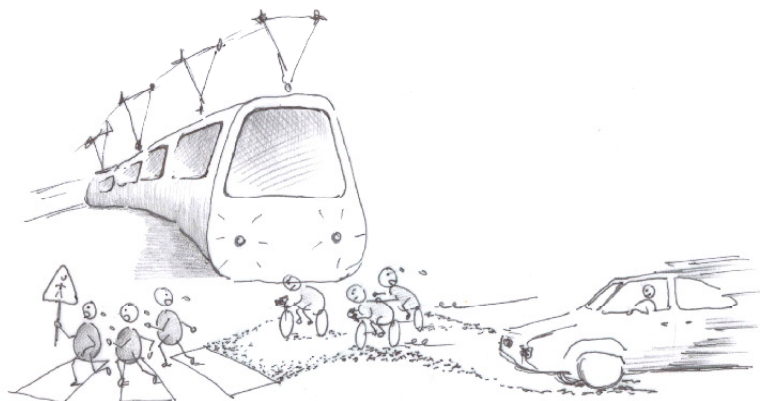

Community Involvement and the Local Economy:

Part b) of policy GP4a:

Development should contribute toward meeting the social needs of communities within the City of York (including housing, community and recreational facilities, car clubs, recycling facilities and communal laundry blocks) and to safe and socially inclusive environments.

Part c) of policy GP4a:

Development should maintain or increase the economic prosperity and diversity of the City of York, and maximise employment opportunities (including supporting local goods and services providing training and employment for local unemployed and young people).

3.4 The Council encourages community involvement at every opportunity and at the earliest stage of the development process. Early community involvement may help to overcome any objections that may arise at a later date. For more information please see our Statement of Community Involvement*, at

* The Statement of Community Involvement (SCI) sets out the Council's proposals for how the community will be involved, both in the production of planning documents, and through consultation on planning applications.

www.york.gov.uk/environment/Planning/Local_development_framework/Statement_of_comm_involve/ . The Council also encourages the use of locally sourced materials and provision of employment for local residents.

3.5 When addressing parts b) and c) of Policy GP4a, the following questions should be answered:

- In what way have you involved those communities/neighbours adjacent to the proposed development?
- Will the proposed development use local labour during construction?
- What percentage of materials used will be sourced locally (where available)?
- Will the construction of the development provide any training opportunities for local people?

Design:

Part d) of policy GP4a:

Development should be of a high quality design, with the aim of conserving and enhancing the local character, heritage and distinctiveness of the City.

3.6 When considering planning applications the intention is to seek a standard of design that will secure an attractive development and safeguard or enhance the environment. The Council requires development of the highest quality design, as a fundamental part of enhancing environmental quality and sustainability. It is also recommended that any associated Village Design Statements and Conservation Area documents are referred to at this stage.

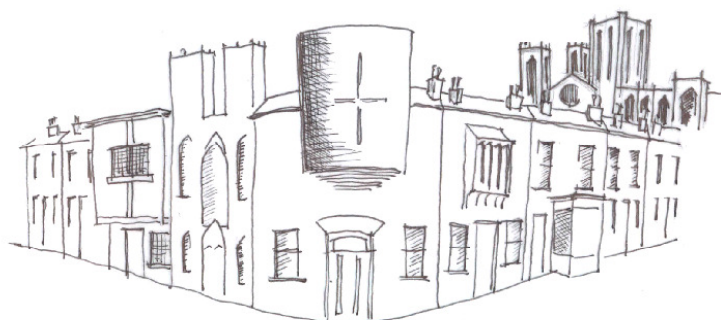

3.7 When addressing part d), the following questions should be answered:

- How does the design make a positive visual contribution to the site and to adjacent areas?
- How does the design respect the character of the area and of adjoining properties?

- Have the windows been sized according to the direction of the building to minimise heat loss and maximise solar gain, if not why not?
- Where possible, how have existing buildings been re-used?
- Is the height of building similar to those around it to prevent heat loss by exposure and to reduce energy demands? Are the buildings grouped together for the same reasons?
- Does the development proposal have thermal mass materials in it that will absorb and release heat (e.g. Concrete)? (For more information visit www.itienenergy.com)
- How does the development proposal employ the use of natural ventilation systems to provide cooling? (For more information visit www.carbontrust.co.uk)
- In what way does the design of the development address crime prevention?

Resources:

Part e) of policy GP4a:

Development should minimise the use of non-renewable resources, re-use materials already on the development site, and seek to make use of grey water systems both during construction and throughout the use of the development. Any waste generated through the development should be managed safely, recycled and/or reused. The 'whole life' * costs of materials should be considered.

3.8 When addressing part e), the following questions should be answered. By responding to the questions and providing the relevant evidence in your sustainability statement, the minimum standards below should be satisfied:

- In what way have opportunities been maximised to re-use and recycle materials?
- How does the proposal consider the 'whole life' costs of the development?
- How does the proposal maximise the use of materials with reduced environmental impact?
- How does the proposal demonstrate how construction waste will be reduced during construction and occupation of the development?
- What already exists on-site in terms of resources?

* Whole life costs of a material and building identify the total costs of making, running and maintaining it. For more information see further advice in Appendix 3.

- Has an Energy Assessment been undertaken and submitted? (For more information visit www.est.org.uk).
- In what way have you included details of water efficiency measures? (For more information visit www.ofwat.gov.uk).
- Does the proposal provide fitted water butts for every development with a garden or landscape area? (For more information visit www.yorkshirewater.com).

3.9 Construction accounts for one-third of waste materials in the UK, including some 1.3 million tonnes of products that are delivered to site each year and not used. Analysis by leading firms in the construction industry shows that good practice in materials ordering and managing site waste can save up to 20% of materials on site. Together with financial savings from segregation and recycling wastes to avoid landfill, this can reduce build costs by 3%. Applicants are reminded that recovered materials can be used as components in new construction.

Minimum standard (Carbon emissions and energy use): The Council will require an energy assessment of the proposed development. The energy assessment should demonstrate that the following order of preference has been applied to reduce the carbon emissions: reduce demand for energy (e.g. avoid/reduce heating/cooling requirements); use of energy efficiency measures to meet demand, including community combined heat and power (CCHP), trigeneration and district heating; incorporating on-site renewable energy equipment. The assessment is required to acknowledge the changing climate through the lifetime of the proposed development.

Minimum standard (Water use): The Council will require the following water efficiency measures to be met: dual flush Ecs (4/6) litre; shower nominal flow rates less than 9 litres/minute; controls on urinals or waterless urinals (where installed); flow restricted spray taps; water meters with pulsed output for each building/dwelling. The sustainability statement must also include an evaluation of rainwater harvesting systems, grey water systems and Sustainable Urban Drainage Systems (SUDS). For more information visit www.environment-agency.gov.uk

Pollution and Site Management:

Part f) of policy GP4a:

Development should minimise pollution, including that relating to air, water, land, light and noise.

3.10 When addressing part f), the following questions should be answered. By responding to the questions and providing the relevant evidence in your sustainability statement, the minimum standards below should be satisfied:

In terms of Pollution:

- What measures have been incorporated to reduce pollution, including light pollution?
- In what way does the proposal seek to reduce rainwater run-off?
- In what way does the proposal discourage the use of materials used in manufacture that are known to deplete the ozone layer such as CFC's and HCFC's?
- If the proposal includes timber products will these be FSC certified or from another externally accredited source for sustainably managed timber?
- What measures have been incorporated to avoid pollution of the water environment?

In terms of Site Management:

- How will the proposal meet the requirements of the *Considerate Constructor Scheme* or equivalent.

3.11 *The Considerate Constructors Scheme*, started in 1997, is a voluntary Code of Considerate Practice, which is adopted by participating construction companies, and everyone involved on the construction site. The scheme aims to improve the image of construction. The Code commits those contractors in the scheme to be considerate and good neighbours, as well as clean, respectful, safe, environmentally conscious, responsible and accountable. The scheme covers all construction activity within the UK, and is open to construction companies of all types and size. For more information visit:
www.considerateconstructorscheme.org.uk

Minimum Standard (Pollution): Materials that have used CFC's and HCFC's in their manufacture must be avoided unless it can be shown that no alternatives are available. All timber and timber products must be FSC accredited (or similar independent accreditation system for timber produced from sustainably managed forests).

Minimum Standard (Site Management): The applicant should commit to achieving a level of performance equivalent to that required under the *Considerate Constructors Scheme*. The Council will expect this to be supported by a commitment to achieve certification under the *Considerate Constructors Scheme* unless the applicant can demonstrate why this cannot be achieved.

Landscape and Wildlife:

Part g) of policy GP4a:

Development should conserve and enhance natural areas and landscape features, provide both formal and informal open space, wildlife areas and room for trees to reach full growth.

3.12 It is important that cultivation of green areas are considered to counteract carbon emissions. Hard standing should always be kept to a minimum to ensure that there is sufficient food for the local wildlife and to generally provide a sense of wellbeing. For a definition of a “Natural Area”, see Appendix 2.

3.13 When addressing part g), the following questions should be answered:

- Does the proposal include landscaping/public space and if so to what extent?
- How has the existing or proposed landscaping treatment been assessed for how it can contribute to the biodiversity, comfort and amenity of a development by excluding cold winds and creating sun traps or cooling in gardens and open space?
- How does it make use of/create an external open area, providing shelter, sunny aspects and shade?
- In what way does the proposal include the retention or provision of natural areas including hedge rows, verges and river banks?
- Does the proposal include a green or brown roof? If not, please give reasons why this is not feasible. (For more information visit: www.groundwork-sheffield.org.uk/upload/documents/document48.pdf)
- In what way does the development proposal include space for wildlife such as specifically designed landscaping or roof integrated bat boxes?
- How does the proposal include planting that uses indigenous species?
- In what way does the proposed development effect any existing trees, and how will it enhance the stock of trees in the locality?
- How does the proposal incorporate the linkages between green spaces and accessible urban greenspaces?
- Has the impact of the development on soil erosion and compaction been considered? If so, how can the effects be controlled/mitigated to have a positive impact on geodiversity and biodiversity?

Renewable Energy:

Part h) of policy GP4a:

Development should maximise the use of renewable resources on development sites and seek to make use of renewable energy sources, such as heat exchangers and photovoltaic cells.

Minimum Standard (Renewable Energy): The sustainability statement must demonstrate that at least 5% of the expected energy demand for the development will be provided for through on site renewable generation for heat and/or electricity. In addition, it should be identified how the development could accommodate renewable energy installations in the future, for example the number/area of south facing roofs.

- 3.14 Renewable energy is the generation of heat, hot water or electricity from renewable resources such as the sun, wind and earth. Government grants are now available for many technologies and for different development types including commercial. More information can be found on the Low Carbon Buildings Programme website www.lowcarbonbuildings.org.uk. In order to qualify for a grant the development must first demonstrate energy efficiency and have planning consent for the technologies.
- 3.15 When addressing part h), the following questions should be answered in order to meet the minimum standard above:
- How does the proposal include the use of renewable energy?
 - What percentage of the development's energy will be provided by on-site renewables?
 - In what way have you evaluated the use of different renewable energy technologies in the proposed development, both in the short and long term?

Recycling:

Part i) of policy GP4a:

Development should make adequate provision for the storage and collection of refuse and recycling.

- 3.16 When addressing part i), the following questions should be answered:
- How does the proposal provide adequate space for waste and green waste wheeled bins?

Refurbishments, Conversions, and Changes of Use

- 3.17 The reuse of existing buildings can be the most sustainable development option – many tonnes of resources and carbon emissions are locked up in our existing building stock. Their reuse and renovation saves resources and carbon

emissions. However it must be recognised that the retention of some buildings is not the most sustainable long-term option due to their condition or inability to meet higher insulation standards. In some cases demolition and the reuse of materials may be the most sustainable option. It is for the applicant to justify the decision to demolish and new build as opposed to renovation in the submitted sustainability statement to the satisfaction of the Local Planning Authority.

- 3.18 The requirements for refurbishments, conversions, and changes of use are the same as those set out above in this section. It is recognised that some development, particularly refurbishments may struggle to meet the requirements of this section. In such cases it is for the applicant to explain and justify non-compliance in the submitted sustainability statement to the satisfaction of the Local Planning Authority.
- 3.19 For further advice and best practice see Appendices 2 and 3.

4. Residential Developments (New Build)

For residential developments of 1 dwelling unit and above.

- 4.1 Applicants proposing new residential developments of one new dwelling or more, will be required to submit a sustainability statement which addresses all of the criteria set out in Local Plan policy GP4a (shown in Figure 1).

Minimum Standard: Applications for new build residential developments of 1 dwelling unit and above will be required to achieve a Code for Sustainable Homes Level 3***. This will need to be achieved at the Design and Procurements and Post Construction stages.

- 4.2 As part of the sustainability statement, developers of new homes are required to take into account the “Code for Sustainable Homes”, a new Government standard introduced in April 2007, along with a target that all new homes are required to be “zero carbon” by 2016. Appendix 4 provides detailed information on the Code for Sustainable Homes and paragraph 4.9 expands on the zero carbon concept. The sustainability statement must also state how the development will meet the minimum standards (in water use, recycling, renewable energy and recycling) set out at the end of this section.
- 4.3 If the proposal is to be built in phases then the LPA will require a sustainability statement with the initial or outline application setting out principles, aims and commitments to achieve the requirements for the whole of the development. These requirements will be conditioned at the outline stage as reserved matters. As each phase comes forward for approval, a detailed sustainability statement would be required to ensure that the most up to date relevant standards are met.



Code for Sustainable Homes

4.4 The Code for Sustainable Homes uses a sustainability rating system indicated by stars to communicate the overall sustainability performance of a home. Code 1* is the lowest level and 6***** is the highest level. The code level achieved is awarded following a design assessment of the proposal and a post construction assessment following completion of the development. The Code covers the following categories:

- Energy/CO₂
- Water
- Materials
- Surface water run-off
- Waste
- Pollution
- Health and well-being
- Management
- Ecology

4.5 In recognition of the importance of water and energy efficiency, there is a requirement to meet at least a Code Level 3 star rating in these categories. Whereas the other categories will have to achieve an overall average of Code Level 3.

4.6 In addition to meeting the Code Level 3, the following local minimum standards should be met:

Resources:

Minimum standard (Water use): The sustainability statement must also include an evaluation of rainwater harvesting systems, grey water systems and sustainable urban drainage systems (SUDS). For more information visit www.environment-agency.gov.uk Also a water butt is required to be fitted to all new residential properties with gardens or landscape areas.

Renewable Energy:

4.7 Renewable energy is the generation of heat, hot water or electricity from renewable resources such as the sun, wind and earth. Government grants are now available for many technologies and for different development types including commercial. More information can be found on the Low Carbon Buildings Programme website www.lowcarbonbuildings.org.uk. In order to qualify for a grant the development must first demonstrate energy efficiency and have planning consent for the technologies.

Minimum Standard (Renewable Energy): The applicant must demonstrate that a % of the expected energy demand for the development will be provided for through on site renewable generation for heat and/or electricity. For developments of 5 dwelling units and above, 10% of energy will be expected to be produced on site, for developments of 4 dwellings and under, 5% of energy will be expected to be produced on site. In addition parts of the development should be identified that could accommodate renewable energy installations in the future, for example the number/area of south facing roofs.

Recycling:

- 4.8 The City of York Council runs a range of recycling services for residents; kerbside collection for recyclates, green waste collections and a wide selection of 'take to' recycling banks around the city. In order to continue this service and expand it the following local minimum standards have been provided to ensure that all residents have the opportunity to take advantage of the services offered and also have the space in their property to temporarily store materials before they are collected by the council. Full details of the requirements are in Appendix 5.

Minimum Standard (Recycling): Residential proposals for detached, semi-detached or terraced properties with gardens or forecourts must provide external space at each property to store at least 2 X 180 litre wheeled bin (one black for residual waste and one green for garden waste) either within a bin store or outside the property.

Residential proposals for detached, semi-detached or terraced properties with gardens or forecourts must provide external space at each property to store at least 2 X boxes and two bags for household recycling. This is in addition to the space required for residual waste and green waste bins.

Proposals for communal properties such as flats. Space needs to be provided externally for the storage of the following at each property:

1 X 180 Litre bin capacity for residual waste (this can be combined into larger bins by using a simple calculation e.g. a block with 6 properties x 180 litres = 1080 litres, therefore 1x 1100 litre bin is needed or a block of 20 properties x 180 litres= 3600 litres, therefore 3x 1100 litre bins are needed).

1 X 55 litre green box, (2-wheeled bins which can be shared between properties could be used for recyclable materials, e.g. 3 no. 240 litre bins between 4/5 properties with 1 for glass, 1 for plastics & cans and 1 for paper & cardboard).

2 X bags

- 4.9 A zero carbon property is one that achieves zero net carbon emissions from energy use on site on an annual basis. Energy use on site relates to all energy use of the building, structures and non-building uses (e.g. street lighting), excluding transport. To achieve zero net carbon emissions, the building would need to be powered and heated by renewable energy. Fossil fuels may be used on site, as long as there is sufficient export of renewable heat, cooling and/or power to offset the resulting carbon emissions.

- 4.10 For information regarding development of existing buildings, please see sections 5 and 6. For further advise and best practice, see Appendices 2 and 3.

5. Development of Existing Residential Dwelling Units (of 5 dwellings and above).

Refurbishments, Conversions, and Changes of Use

- 5.1 The reuse of existing buildings can be the most sustainable development option – many tonnes of resources and carbon emissions are locked up in our existing building stock. Their reuse and renovation saves resources and carbon emissions. However it must be recognised that the retention of some buildings is not the most sustainable long-term option due to their condition or inability to meet higher insulation standards. In some cases demolition and the reuse of materials may be the most sustainable option. It is for the applicant to justify the decision to demolish and new build as opposed to renovation in the submitted sustainability statement to the satisfaction of the Local Planning Authority.
- 5.2 If the proposal is to be built in phases then the LPA would expect a sustainability statement with the initial or outline application setting out principles, aims and commitments to achieve the requirements for the whole of the development. These requirements should be conditioned at the outline stage as reserved matters. As each phase comes forward for approval, a detailed sustainability statement would be required to ensure that the most up to date relevant standards are met.

Minimum Standard: For refurbishment work to residential developments of 5 dwellings and above, an Eco-homes standard of 'Very Good' will be required. Applicants will need to appoint a BREEAM assessor to undertake this assessment.

- 5.3 In addition to meeting Eco-Homes standard 'very good', the following minimum standards should also be met:

Pollution and Site Management:

Minimum Standard (Site Management): All development requiring demolition of an existing building should include measures to maximise the reclamation of materials for recycling and reuse. For these developments, the sustainability statement must demonstrate a commitment to the implementation of the Institute of Civil Engineers (ICE) Demolition Protocol or equivalent.

- 5.4 Reducing the construction industry's demand for primary resources is vital to improving the sustainability of construction. The *Demolition Protocol* shows how the production of demolition material can be linked to its specification as a high value material in new buildings. Further information is available on the Institute of Civil Engineers website www.ice.org.uk.
- 5.5 The protocol has 2 main components:
- (i) Demolition Recovery Index:

The protocol shows how a building audit can be used to generate a *Demolition Recovery Index* (DRI). The DRI allows project teams to identify the potential for cost effectively recovering material from demolition. In addition, the DRI provides planning authorities with a tool for ensuring that demolition methodologies reflect national and local authority policies on waste management and sustainable development.

(ii) New Build Recovery Index:

The development of new standards, for example through the *Construction Products Directive*, means that the potential for specifying demolition recycle in new buildings is continually increasing. The protocol's New Build Recovery Index (NBRI) provides a tool for establishing the potential percentage and quantity of recovered materials that can be specified in a new building or other structure. Where a project involves demolition and new build, the NBRI can be linked to the DRI to provide project teams with a model for assessing the efficiency of resource use for the whole project.

Minimum Standard (Waste and Landfill): A Site Waste Management Plan must be submitted, and should be prepared in accordance with the DTI (Department of Trade and Industry) guidance on Site Waste Management Plans. For more information visit www.dti.gov.uk

The plan should include the following steps:

- 1) Assign responsibility to producing the plan;
- 2) Identify the types and quantities of waste;
- 3) Identify waste management options;
- 4) Identify waste management sites and contractors;
- 5) Carry out necessary training;
- 6) Plan for efficient materials and waste handling;
- 7) Monitor how much and what types of waste are produced;
- 8) Monitor and implement the plan;
- 9) Review how the plan worked at the end of the project.

5.6 Construction accounts for one-third of waste materials in the UK, including some 1.3 million tonnes of products that are delivered to site each year and not used. Analysis by leading firms in the construction industry shows that good practice in materials ordering and managing site waste can save up to 20% of materials on site. Together with financial savings from segregation and recycling wastes to avoid landfill, this can reduce build costs by 3%.

5.7 Applicants are reminded that recovered materials can be used as components in new construction. In particular, applicants should refer to the minimum standard on the use of reclaimed/recycled materials in construction and the ICE Demolition Protocol outlined in paragraphs 5.4 and 5.5 above.

Minimum Standard (Pollution): The Sustainability Statement must:

- demonstrate the avoidance of materials that have used CFCs and HCFCs in their manufacture unless it can be shown that no alternatives are available;
- demonstrate that all timber and timber products used in the proposed development will be FSC accredited (or similar independent accreditation system for timber produced from sustainably managed forests); and
- demonstrate that lighting schemes are provided that are designed to reduce the occurrence of light pollution. Schemes will be expected to employ energy efficient lighting that also reduces light scatter. The council will normally accept proposals in line with the Institute of Lighting Engineers Guidance GNO1 2005.

5.8 Guidance on reducing light pollution has been prepared by the Institute of Lighting Engineers (ILE) who have produced a note on the reduction of obtrusive light GNO1, 2005. This provides good practice guidance and environmental designations in zones of 1 to 5, which designate area characteristics according to their use and lighting requirements. The zones range from the darkest areas in isolated rural sites to the lightest in a city centre with a lot of night time activity. Within these zones the guidance specifies the lighting installations that would be acceptable. In addition it provides curfew times in which appropriate light installations should be switched off, i.e. after 23:00hrs. It would be expected that applicants would follow these guidelines, identify the environmental zone in which the site lies and also undertake the actions suggested in the guidance. This information will need to be submitted as part of the sustainability statement.

Minimum Standard (Site Management): The applicant should commit to achieving a level of performance equivalent to that required under the *Considerate Constructors Scheme*. The Council will expect this to be supported by a commitment to achieve certification under the *Considerate Constructors Scheme* unless the applicant can demonstrate why this cannot be achieved.

5.9 *The Considerate Constructors Scheme*, started in 1997, is a voluntary Code of Considerate Practice, which is adopted by participating construction companies, and everyone involved on the construction site. The scheme aims to improve the image of construction. The Code commits those contractors in the scheme to be considerate and good neighbours, as well as clean, respectful, safe, environmentally conscious, responsible and accountable. The scheme covers all construction activity within the UK, and is open to construction companies of all types and size. For more information visit:
www.considerateconstructorsscheme.org.uk

Renewable Energy:

Minimum Standard (Renewable Energy): The sustainability statement must demonstrate that at least 10% of the expected energy demand for the development will be provided for through on site renewable generation for heat and/or electricity. In addition parts of the development are required to be identified to allow accommodation of renewable energy installations in the future, for example the number/area of south facing roofs and potential wind turbine locations.

- 5.10 Renewable energy is the generation of heat, hot water or electricity from renewable resources such as the sun, wind and earth. Government grants are now available for many technologies and for different development types including commercial. More information can be found on the *Low Carbon Buildings Programme* website www.lowcarbonbuildings.org.uk. In order to qualify for a grant the development must first demonstrate energy efficiency and have planning consent for the technologies.

Recycling:

- 5.11 The City of York Council runs a range of recycling services for residents; curbside collection for recyclates, green waste collections and a wide selection of 'take to' recycling banks around the city. In order to continue this service and expand it the following local minimum standards have been provided to ensure that all residents have the opportunity to take advantage of the services offered and also have the space in their property to temporarily store materials before they are collected by the council. Full details of the requirements are in Appendix 5.

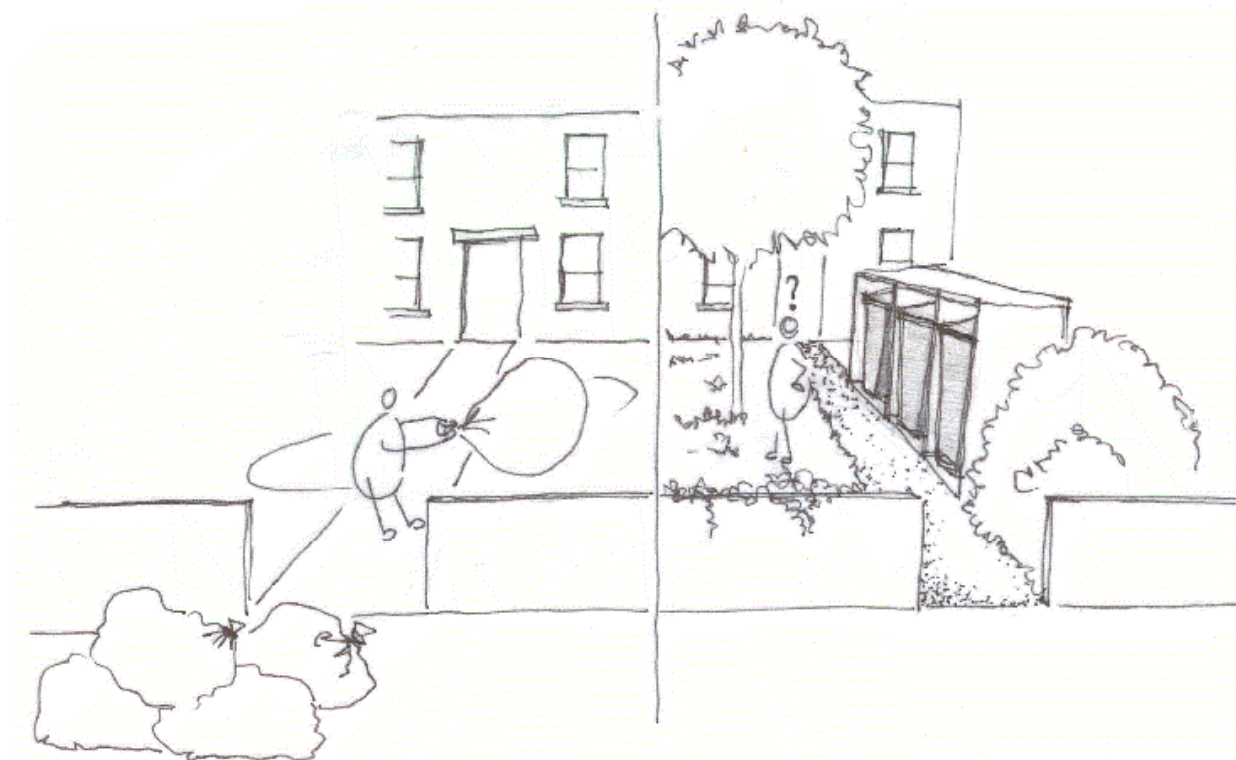

Minimum Standard (Recycling): Residential proposals for detached, semi-detached or terraced properties with gardens or forecourts must provide external space at each property to store at least 2 X 180 litre wheeled bin (one black for residual waste and one green for garden waste) either within a bin store or outside the property.

Residential proposals for detached, semi-detached or terraced properties with gardens or forecourts must provide external space at each property to store at least 2 X boxes and two bags for household recycling. This is in addition to the space required for residual waste and green waste bins.

Proposals for communal properties such as flats. Space needs to be provided externally for the storage of the following at each property:

1 X 180 Litre bin capacity for residual waste (this can be combined into larger bins by using a simple calculation e.g. a block with 6 properties x 180 litres = 1080 litres, therefore 1x 1100 litre bin is needed or a block of 20 properties x 180 litres= 3600 litres, therefore 3x 1100 litre bins are needed).

1 X 55 litre green box, (2-wheeled bins which can be shared between properties could be used for recyclable materials, e.g. 3 no. 240 litre bins between 4/5 properties with 1 for glass, 1 for plastics & cans and 1 for paper & cardboard).

2 X bags

5.12 For more information on BREEAM Eco-Homes see Appendix 1. For further advice and best practice see Appendices 2 and 3.

6. Development of Existing Residential Dwelling Units (of 4 dwellings and below).

Refurbishments, Conversions, and Changes of Use

- 6.1 The reuse of existing buildings can be the most sustainable development option – many tonnes of resources and carbon emissions are locked up in our existing building stock. Their reuse and renovation saves resources and carbon emissions. However it must be recognised that the retention of some buildings is not the most sustainable long-term option due to their condition or inability to meet higher insulation standards. In some cases demolition and the reuse of materials may be the most sustainable option. It is for the applicant to justify the decision to demolish and new build as opposed to renovation in the submitted sustainability statement to the satisfaction of the Local Planning Authority.
- 6.2 **For refurbishment work to residential developments of 4 dwelling units or less**, It is recognised that some development, particularly refurbishments may struggle to meet the requirements below. In such cases it is for the applicant to explain and justify non-compliance in the submitted sustainability statement to the satisfaction of the Local Planning Authority. The following minimum standards should be met:

Resources:

- 6.3 When addressing part e) of policy GP4a (see figure , the following questions should be answered. By responding to the questions and providing the relevant evidence in your sustainability statement, the minimum standards below should be satisfied:
- In what way have opportunities been maximised to re-use and recycle materials?
 - How does the proposal consider the ‘whole life’ *costs of the development?
 - How does the proposal maximise the use of materials with reduced environmental impact?
 - How does the proposal demonstrate how construction waste will be reduced during construction and occupation of the development?
 - What already exists on-site in terms of resources?
 - Has an Energy Assessment been undertaken and submitted? (For more information visit www.est.org.uk).

* Whole life costs of a material and building identify the total costs of making, running and maintaining it. For more information see further advice in Appendix 2.

- In what way have you included details of water efficiency measures? (For more information visit www.ofwat.gov.uk).
- Does the proposal provide fitted water butts for every development with a garden or landscape area? (For more information visit www.yorkshirewater.com).

6.4 Construction accounts for one-third of waste materials in the UK, including some 1.3 million tonnes of products that are delivered to site each year and not used. Analysis by leading firms in the construction industry shows that good practice in materials ordering and managing site waste can save up to 20% of materials on site. Together with financial savings from segregation and recycling wastes to avoid landfill, this can reduce build costs by 3%. Applicants are reminded that some recovered materials can be used as components in new construction.

Minimum standard (Carbon emissions and energy use): The Council will require an energy assessment of the proposed development. The energy assessment must demonstrate that the following order of preference has been applied to reduce the carbon emissions: reduce demand for energy (e.g. avoid/reduce heating/cooling requirements); use of energy efficiency measures to meet demand, including community combined heat and power (CCHP), trigeneration and district heating; incorporating on-site renewable energy equipment. The assessment is required to acknowledge the changing climate through the lifetime of the proposed development.

Minimum standard (Carbon emissions and energy use): Reference in the sustainability statement should be also made to the Energy Savings Trust (EST) Best Practice standards. The Council expects an improvement on current Building Regulations standard of at least Best Practice 25%. The EST Best Practice standards recommend improvements on current Building Regulations Part L 1A as follows: 10% (Good Practice); 25% (Best Practice); and 60% (Advanced Standard). The EST research shows that all development can meet the 10% improvement target at no extra cost and recommends that a target of 25% improvement on current Building Regulations Part L 1A targets should be set for new residential developments.

Minimum standard (Water use): The sustainability statement must also include an evaluation of rainwater harvesting systems, grey water systems and sustainable urban drainage systems (SUDS). The Council will require the following water efficiency measures to be met: dual flush Ecs (4/6) litre; shower nominal flow rates less than 9 litres/minute; controls on urinals or waterless urinals (where installed); flow restricted spray taps; water meters with pulsed output for each building/dwelling. The sustainability statement must also include an evaluation of rainwater harvesting systems, grey water systems and Sustainable Urban Drainage Systems (SUDS). For more information visit www.environment-agency.gov.uk. Also a water butt should be fitted to all new residential properties with gardens or landscape areas.

Pollution and Site Management:

6.5 When addressing part f) of policy GP4a (see Figure 1), the following questions should be answered. By responding to the questions and providing the relevant

evidence in your sustainability statement, the minimum standards below should be satisfied:

In terms of Pollution:

- What measures have been incorporated to reduce pollution, including light pollution?
- In what way does the proposal seek to reduce rainwater run-off?
- In what way does the proposal discourage the use of materials used in manufacture that are known to deplete the ozone layer such as CFC's and HCFC's?
- If the proposal includes timber products will these be FSC certified or from another externally accredited source for sustainably managed timber?
- What measures have been incorporated to avoid pollution of the water environment?

In terms of Site Management:

- How will the proposal meet the requirements of the *Considerate Constructor Scheme* or equivalent.

6.6 *The Considerate Constructors Scheme*, started in 1997, is a voluntary Code of Considerate Practice, which is adopted by participating construction companies, and everyone involved on the construction site. The scheme aims to improve the image of construction. The Code commits those contractors in the scheme to be considerate and good neighbours, as well as clean, respectful, safe, environmentally conscious, responsible and accountable. The scheme covers all construction activity within the UK, and is open to construction companies of all types and size. For more information visit: www.considerateconstructorsscheme.org.uk

Minimum Standard (Pollution): Materials that have used CFC's and HCFC's in their manufacture must be avoided unless it can be shown that no alternatives are available. All timber and timber products must be FSC accredited (or similar independent accreditation system for timber produced from sustainably managed forests).

Minimum Standard (Site Management): The applicant should commit to achieving a level of performance equivalent to that required under the *Considerate Constructors Scheme*. The Council will expect this to be supported by a commitment to achieve certification under the *Considerate Constructors Scheme* unless the applicant can demonstrate why this cannot be achieved.

Renewable Energy:

6.7 Renewable energy is the generation of heat, hot water or electricity from renewable resources such as the sun, wind and earth. Government grants are now available for many technologies and for different development types including commercial. More information can be found on the Low Carbon Buildings Programme website www.lowcarbonbuildings.org.uk. In order to qualify for a grant the development must first demonstrate energy efficiency and have planning consent for the technologies.

Minimum Standard (Renewable Energy): The sustainability statement must demonstrate that at least 5% of the expected energy demand for the development will be provided for through on site renewable generation for heat and/or electricity. In addition parts of the development will be required to be identified to accommodate renewable energy installations in the future, for example the number/area of south facing roofs.

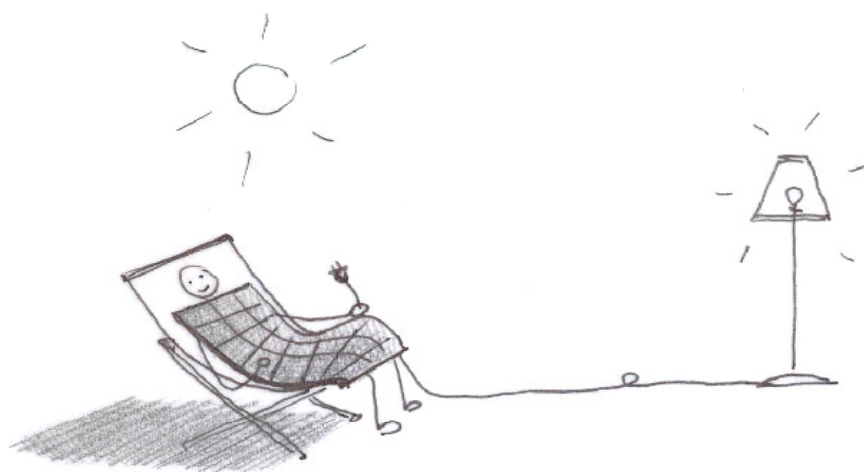

Recycling

6.8 The City of York Council runs a range of recycling services for residents; kerbside collection for recyclates, green waste collections and a wide selection of 'take to' recycling banks around the city. In order to continue this service and expand it the following local minimum standards have been provided to ensure that all residents have the opportunity to take advantage of the services offered and also have the space in their property to temporarily store materials before they are collected by the council. Full details of the requirements are in Appendix 5.

Minimum Standard (Recycling): Residential proposals for detached, semi-detached or terraced properties with gardens or forecourts must provide external space at each property to store at least 2 X 180 litre wheeled bin (one black for residual waste and one green for garden waste) either within a bin store or outside the property.

Residential proposals for detached, semi-detached or terraced properties with gardens or forecourts must provide external space at each property to store at least 2 X boxes and two bags for household recycling. This is in addition to the space required for residual waste and green waste bins.

Proposals for communal properties such as flats. Space needs to be provided externally for the storage of the following at each property:

1 X 180 Litre bin capacity for residual waste (this can be combined into larger bins by using a simple calculation e.g. a block with 6 properties x 180 litres = 1080 litres, therefore 1x 1100 litre bin is needed or a block of 20 properties x 180 litres= 3600 litres, therefore 3x 1100 litre bins are needed).

1 X 55 litre green box, (2-wheeled bins which can be shared between properties could be used for recyclable materials, e.g. 3 no. 240 litre bins between 4/5 properties with 1 for glass, 1 for plastics & cans and 1 for paper & cardboard).

2 X bags

6.9 For further advice and best practice see Appendices 2 and 3.

7. Domestic Extensions

Extensions to existing residential dwellings.

- 7.1 If a domestic extension is being proposed then a sustainability statement must be submitted. The sustainability statement can be submitted in the form of a questionnaire which can be found in this section of the IPS, or can be obtained separately by contacting the Council planning team (see Appendix 2 for contacts). The statement must address all of the relevant criteria set out in policy GP4a of the Local Plan (Figure 1), which can be found on page 6. Please answer all of the questions and where you consider them not to be relevant to your development, please explain why.

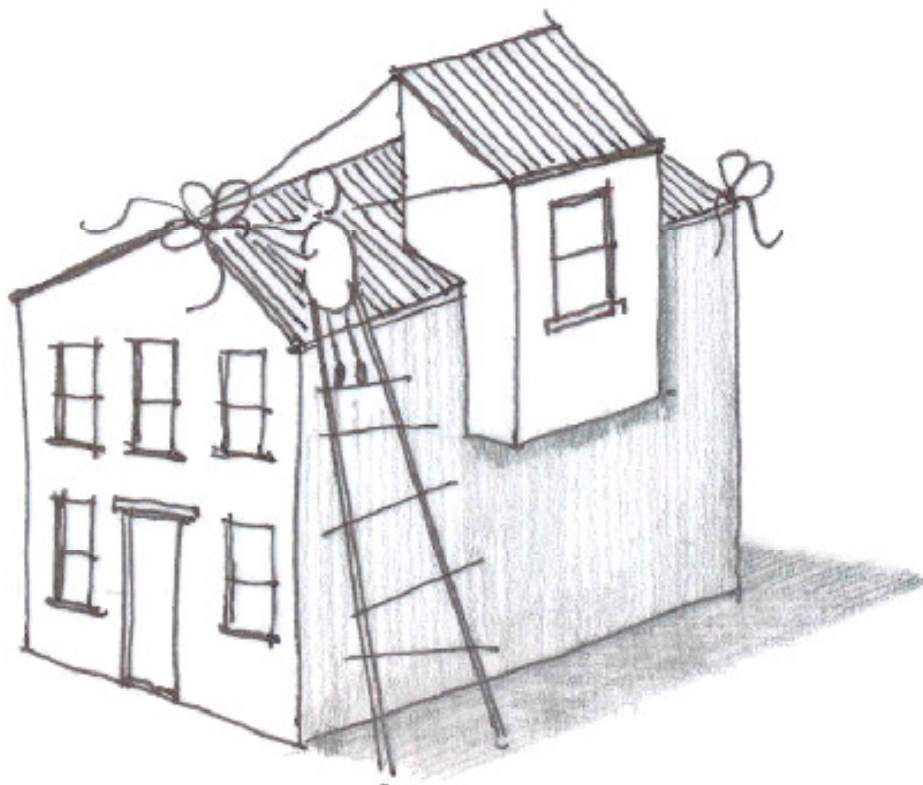

Accessibility:

7.2 When addressing part a) of policy GP4a, please answer the following questions:

- In what way have you considered how the proposal makes provision for the needs of cyclists?

- In what way have you considered whether the development provides cycle storage that is secure, convenient and safe?

Community Involvement and the Local Economy:

7.3 The Council encourages community involvement at every opportunity and at the earliest stage of the process. For domestic extensions this may be done by consulting with neighbours before an application is submitted. This may help to overcome any objections that may arise at a later date. For more information please see our Statement of Community Involvement, at www.york.gov.uk/environment/Planning/Local_development_framework/Statement_of_comm_involve/

7.4 When addressing parts b) and c), of policy GP4a, please answer the following questions:

- How have you kept neighbours informed of your proposals?

- How have you considered using local suppliers/companies during the construction of your development?

Design:

7.5 When considering planning applications the intention is to seek a standard of design that will secure an attractive development and safeguard or enhance the environment.

7.6 When addressing part d), of policy GP4a, please answer the following questions:

- In what way have you considered the ways in which the design makes a positive visual contribution to the site and to adjacent areas whilst respecting the character of the area and of adjoining properties?

- Have you considered how the windows have been sized according to the direction of the building to minimise heat loss and maximise solar gain? Please explain.

- How have you considered how the design could improve on biodiversity and geodiversity? For example, if an area of garden has been lost through a domestic extension, have you considered reducing the impact of this?

Resources:

7.7 When addressing part e), of policy GP4a, please answer the following questions:

- How have you maximised opportunities to reuse and recycle materials?

- How have you considered the 'whole life' costs of the development. Whole life costs of a material and building identify the total costs of making, running and maintaining it. For more information see further advice in Appendix 2?

- In what way have you maximised the use of materials which will reduce environmental impact?

Pollution and Site Management:

7.8 When addressing part f), of policy GP4a, please answer the following questions:

- Have you considered whether the development will lead to an increase in pollution (including light pollution)? If it will, what measures could be used to minimise this?

- How have you considered whether the proposal seeks to reduce rainwater run-off? This could include reducing areas of hard standing and installing a water butt.

Landscape and Wildlife:

7.9 Residential areas can often provide valuable habitats for protected species such as bats. It is important that landscape and wildlife are considered before any building work takes place.

7.10 When addressing part g), of policy GP4a, please answer the following questions:

- In what way have you considered what percentage of the proposed planting contains native species (plants which grow naturally in Britain)?

- Have you looked at how the proposal could incorporate a building design that makes the development more wildlife friendly, for example the inclusion of bird and bat boxes?

Renewable Energy:

7.11 Renewable energy is the generation of heat, hot water or electricity from renewable resources such as the sun, wind and earth. Government grants are now available for many technologies and for different development types. To find out more information, log on to the *Low Carbon Buildings Programme* website www.lowcarbonbuildings.org.uk. In order to qualify for a grant, the development must first demonstrate energy efficiency and have planning consent for the technologies.

7.12 When addressing part h), of policy GP4a, please answer the following questions:

- What measures have been taken to minimise the use of energy such as levels of insulation, energy efficient light bulbs and rated appliances? Further information on Renewable Energy can be found in Appendix 2.

- What measures have been taken to reduce water consumption such as flow restricting sprat taps, low level flush WC (4 / 6 Litre flush), showers with normal flow rates less than 9 litres/ mg, installation of a water butt, or a rain water harvest system?

- In what way have you considered the ways in which the proposal could provide renewable energy on-site such as a solar thermal system to provide hot water? Further information on Renewable Energy can be found in Appendix 2.

Recycling:

7.13 The council provides a number of services so that residents can recycle their household waste. Currently properties with gardens have a black bin for waste (180 litre wheelie bin), a green bin for garden waste (also a 150 litre wheelie bin), a green box for plastic bottles, glass and tins and bags for cardboard and paper. In addition there are recycling banks for other types of recycled waste around the city. Please note that additional information regarding recycling can be found in Appendix 5.

7.14 When addressing part i), of policy GP4a, please answer the following questions:

- Have you considered installing a compost bin to compost kitchen food waste? The Council currently have compost bins on offer at £8 and £10 including delivery. Visit www.york.gov.uk/environment/waste/

- Are you aware of the materials that are collected by the Council as part of the kerbside collection for your area? More information can be found at www.york.gov.uk/environment/waste or by calling the Waste and Recycling team on 01904 553272.

- Does the extension allow for adequate space within the boundary of your property to store waste and recycling containers outside? Please explain. Further information on recycling standards can be found in Appendix 5.

- Have you considered whether your proposal provides space to easily separate waste inside of the property?

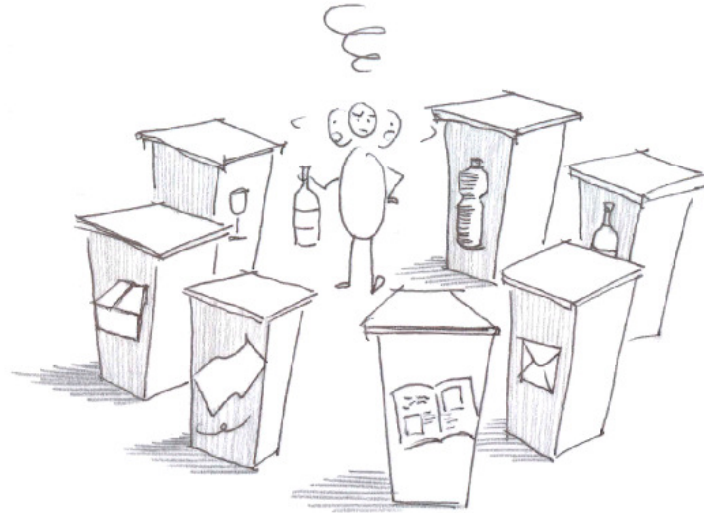

7.15 For further advice and best practice, please refer to Appendices 2 and 3.

Appendix 1: BREEAM

What is BREEAM?

- 1 For over a decade, the Building Research Establishment's Environmental Assessment Method (BREEAM) has been used to assess the environmental performance of both new and existing buildings. It is regarded by the UK's construction and property sectors as the measure of best practice in environmental design and management. BREEAM assessments cover a wide range of environmental issues and present the results in a way that is widely understood by those involved in property procurement and management.
- 2 BREEAM assessments cover a range of building types, including offices, homes (known as EcoHomes); industrial units; retail units; schools; leisure centres; and laboratories. BREEAM assesses the performance of buildings in the following areas:
 - *management*: overall management policy, commissioning site management and procedural issues
 - *energy use*: operational energy and carbon dioxide (CO₂) issues
 - *health and well-being*: indoor and external issues affecting health and well-being
 - *pollution*: air and water pollution issues
 - *transport*: transport-related CO₂ and location-related factors
 - *land use*: greenfield and brownfield sites
 - *ecology*: ecological value conservation and enhancement of the site
 - *materials*: environmental implication of building materials, including life-cycle impacts
 - *water*: consumption and water efficiency
- 3 Credits are awarded in each area according to performance. A set of environmental weightings then enables the credits to be added together to produce a single overall score. The building is then rated on a scale of **PASS**, **GOOD**, **VERY GOOD** or **EXCELLENT**, and a certificate awarded that can be used for promotional purposes.

Why BREEAM?

4. The BREEAM rating system is a nationally recognised assessment method to reduce the environmental impact of buildings and development. It is a standardised format developed by the Building Research Establishment over many years. It is particularly useful as it seeks to incorporate sustainable design and construction elements into a proposal at the earliest stage thus helping to make them more cost effective. Development; what is built and how it is built contributes to nearly 50% of the countries carbon dioxide emissions (the main green house gas which is contributing to global warming and climate change). It is the responsibility to all individuals and organisations to seek to reduce their impact on the environment, using the BREEAM standard is one way to ensure new development is doing this.

5. The BREEAM family of assessment methods and tools are all designed to help construction professionals understand and mitigate the environmental impacts of the developments they design and build. The assessment takes the overall score for the different elements in the process and gives a rating for the development from 'pass', 'good', 'very good' or 'excellent'. The assessment is such that points can be achieved (or not) in different areas to get an overall rating. For example a highly water efficient development in a rural location will score well on water use and management but score poorly on transport issues - conversely a less water efficient development in a city centre location will score poorly in water use and management but do well in transport. As a result both developments could achieve the same BREEAM rating but have done so in different ways. This IPS requires large scale development to meet an overall BREEAM standard of 'very good' at both Design and Procurement and Post Construction assessments, it does not require a very good standard to be reached in all or specific elements of the assessment.
6. Further information on BREEAM and assessors can be found at www.bre.co.uk.

EcoHomes

(only applies to residential refurbishments, conversions and changes of use of 5 dwellings and above)

7. BRE runs a widely-accepted national standard for the design of sustainable housing scheme called *EcoHomes Environmental Ratings for Homes*.
8. The scheme considers wide-ranging environmental concerns and balances these against the need for high-quality, safe and healthy homes. The issues below are optional, the most appropriate issues for each development can be selected and assessed:
 - Energy;
 - Water;
 - Pollution;
 - Materials;
 - Transport;
 - Ecology and land use; and
 - Health and wellbeing.
9. The EcoHomes scheme is straightforward, flexible and independent in assessing how environmentally friendly and sustainable developments are. Developments that meet the necessary standard are given a rating of 'pass', 'good', 'very good' or 'excellent', providing a credible label for new and renovated homes.
10. To get an assessment, information about the proposed development must be entered into a workbook provided by BRE. A licensed assessor, trained and monitored by the BRE, checks the relevant information has been provided and gives a rating, which is passed back to BRE to be approved. For more information visit www.bre.co.uk

Appendix 2: Further Advice:

Key Council Contacts:

Kristina Peat – Sustainability Officer
01904 551666
kristina.peat@york.gov.uk

Development Control or the Transport Planning Unit
01904 551553
planning.enquiries@york.gov.uk

The City Development Team
01904 551466
citydevelopment@york.gov.uk

National Guidance (Planning Policy Guidance and Statements) to be observed:

(These are available to download from www.communities.gov.uk or by calling 020 7944 4400).

- PPS1 – Delivering Sustainable Development
- PPS3 – Housing
- PPS9 – Biodiversity & Geological Conservation
- PPS10 – Planning for Sustainable Waste Management
- PPG15 – Planning for the Historic Environment
- PPG17 – Planning for Open Space, Sport & Recreation
- PPS22 – Renewable Energy
- PPS23 – Planning & Pollution Control
- PPG24 – Planning & Noise.

Regional and Local Guidance:

- For a copy of the emerging draft RSS (December 2004) contact Government Office for Yorkshire and the Humber on: www.goyh.gov.uk
- For a copy of the City of York Development Control Local Plan (2005), please contact the City Development Team or visit: www.planningportal.gov.uk

For more information on Accessibility:

- The UK campaign for better streets and public areas at www.livingstreets.org.uk
- Advice on best practice from the Department of Transport at www.dft.gov.uk
- A copy of the Council Rights of Way Improvement Plan can be obtained by calling 01904 551481, or by email rightsofway@york.gov.uk
- The National Cycling Portal at www.bikeforall.net
- Sustrans (for a useful source of cycle route maps) at www.sustrans.org.uk
- York Cycle Campaign at www.yorkcyclecampaign.org.uk
- National Touring Club at www.ctc.ork.uk
- National Cycling Strategy board at www.nationalcyclingstrategy.org.uk
- Good cycle design www.tfl.gov.uk/cycles

- Good design guidelines www.lancashire.gov.uk/environment/cycling/policy.asp



For more information on Community Involvement and the Local Economy:

- Participation Works! 21 techniques of community participation for the 21st Century at www.renewal.net
- Community Development Foundation at www.cdf.org.uk
- Advice on shaping local environments at www.communityplanning.net
- The Council's Statement of Community Involvement (SCI) www.york.gov.uk/planning or call 01904 552410.
- Department for Education and Skills at www.dfes.gov
- Learning and Skills Council at www.lsc.gov.uk
- Centre for Employment and Enterprise Development at www.ceed.co.uk
- A copy of the Regional Economic Strategy can be downloaded at http://www.yorkshire-forward.com/www/view.asp?content_id=385&parent_id=28

For more information on Design:

- For information regarding climate change and design visit: www.tcpa.org.uk or call 020 7930 8903
- Good street design: www.dft.gov.uk/pgr/sustainable/manforstreets/

For more information on Resources:

- Thermal mass materials www.itienenergy.com
- Naturel ventilation www.carbontrust.co.uk
- More information from www.greenstreet.org.uk which gives information on water saving aimed at housing associations but is equally helpful for all households. Use the menu on the left of the screen to get details of different systems.
- Energy Saving Trust www.est.org.uk
- Water efficiency measures www.ofwat.gov.uk
- Information on water butts www.yorkshirewater.com
- Sustainable Urban Drainage Systems www.environment-agency.gov.uk
- Green infrastructure:
www.leedsmet.ac.uk/as/cudem/projects/country/CIAT_final.pdf or
www.countryside.gov.uk/LAR/Regions/yorkshireAndHumber/activities/Landscape/Countryside_towns/index.asp
- Refer to the publication 'Towards a New Vernacular'. This can be accessed via: www.countryside.gov.uk/LAR/Landscape/PP/New_Vernacular.asp

- Whole life costs of a material and building identify the total costs of making, running and maintaining it. For a material this information is contained in the BRE Green Guide for Specification and includes the environmental impacts, replacement cost, repair and maintenance costs of materials and gives them a rating in terms of their whole life performance – so a material that is more expensive to use in construction but needs less maintenance and will last longer, is actually cheaper (financially and environmentally) over its lifetime than an alternative that had a lower capital cost when first used. The same can be applied to buildings so that energy efficiency measures or renewable energy technologies may have a higher initial capital cost but over the lifetime of the building will save money by reduced running costs.

For more information on Pollution and Site Management:

- North Yorkshire and York waste management company at www.yorwaste.co.uk
- For advice on cleaning up contaminated land visit: www.environment-agency.gov.uk/subjects/landquality/113813/881475/?version=1&lang=e

For more information on Landscape and Wildlife:

- The Association of Wildlife Trusts www.awct.co.uk
- The Institute of Ecology and Environmental Management www.ieem.org.uk
- The Bat Conservation Trust at www.bats.org.uk
- Bats in Buildings at www.batcon.org/binb
- RSPB leaflets 'What's in the roof?' and 'Save the house sparrow initiative' available at www.rspb.org.uk
- Living Roofs www.groundwork-sheffield.org.uk/upload/documents/document47.pdf
- Copies of the Council's existing Biodiversity assessment and landscape management plan are available from the Council for reference. To obtain a copy, please call 01904 551671.
- National Plant Specification: www.gohelios.co.uk
- Plants for amenity landscapes: www.plantspec.org.uk
- Information on piling on contaminated sites can be found at: www.environment-agency.gov.uk
- English Nature Booklets: Living Roofs, wildlife on allotments, email: enquiries@english-nature.org.uk Tel: 01733 455100
- Instant green roofs - www.turf.co.uk
- www.compost.org.uk
- "Natural Areas" are categorisations of the English landscape based on areas which are similar in character associated with wildlife, landforms, geology and land use and human impact. For more information, please visit <http://www.english-nature.org.uk/Science/natural/role.htm>

For more information on Renewable Energy:

- Advice on energy saving and construction waste see the green buildings page at www.big-builders.com/construction.

- More information on energy efficiency and renewable energy can be found at the York Energy Efficiency Advice Centre. Call 0800512012 or visit 20 George Hudson Street, York, Y01 6WR.
- Overview of renewable energy, visit green power at www.ncgp.org
- Advice on renewable energy and how to apply for grants please see the *Low Carbon Buildings* Programme on www.est.org.uk or call 0800 915 7722. Building regulations have certain standards but you should aim for standards above those required by building regulations on energy efficiency and insulation. This will save you money in the longer term.

For more information on Recycling:

- Government-funded programme of free, confidential advice to UK businesses at www.envirowise.gov.uk
- Environmental charity with advice on recycling www.encams.org

For more information about BREEAM:

- www.bre.co.uk
- www.breeam.co.uk
- www.breeam.org/ecohomes

Appendix 3: Best Practice

- 1 Some housing developments now provide dwellings with either 6 months free bus travel or a new bicycle to encourage sustainable travel. One example where this has happened in York is the Birch Park Housing development.
- 2 Developers could provide information packs for new owners, including information on how energy efficient the building is, and also how best to make it as efficient as possible in the future. This is particularly important for residential schemes, but can also be applied to commercial schemes.
- 3 Yorwaste (a waste management company) at Harewood Whin provide aggregates made from waste building materials, (including sand, gravel, crushed rocks, and other bulk materials used by the construction industry). For more information call sales and marketing at Yorwaste on 01609 774400 or visit www.yourwaste.co.uk/recyl/operation
- 4 For domestic alterations a free DIY home energy check is available at the energy efficiency advice centre (EEAC). Call them on 0800 512 012, or see their website www.energypartnership.org.uk
- 5 The government provides grants of up to 50% of the total cost for the installation of renewable energy generation technologies as part of their Low Carbon Buildings programme. The grants are available to residential, public sector and commercial installations. For more information visit www.lowcarbonbuildings.org.uk
- 6 Developers should consider travel initiatives such as car clubs, where people are able to share the cost and running of a car. One example of where this is currently being done for employees at the City of York Council. For more information visit: www.york.gov.uk/transport/Public_transport/car_club
7. “Whizzgo” is York’s Car Club. For a small membership fees cars are available for use on an hourly basis located at convenient parking places around the city. Proposals for large residential developments should seriously consider providing parking bays and cars for the car club within the proposal.
8. A wind turbine may not be an appropriate renewable energy technology for a city centre site but others are. Ground source heat pumps can be hidden under landscape or parking areas associated with a development providing a heating source in the winter and cooling in the summer.
9. If a wind turbine is to be considered as part of the proposal then the following information should be provided with it:
 - a. Photomontage of what it will look like.
 - b. Background noise assessment.
 - c. Independent noise assessment for the model of turbine proposed.
 - d. If it is to be attached to a building a structural survey of that building.

10. A site may have little or no wildlife interest before a development takes place but it does not have to remain so. Using the correct planting and landscape strategy can provide ideal habitat for wildlife, the installation of nest and bat boxes will also make a difference. Green roofs are also a very good way to create habitat.

Appendix 4: The Code for Sustainable Homes

A copy of the Code for Sustainable Homes can be obtained by visiting www.communities.gov.uk or by calling 020 7944 4400.

What is the Code for Sustainable Homes?

The following text is a summary of the Code for Sustainable Homes guidance (December 2006).

- 1 The Code for Sustainable Homes has been developed to enable a step change in sustainable building practice for new homes. It has been prepared by the Government in close working consultation with the Building Research Establishment (BRE) and Construction Industry Research and Information Association (CIRIA), and through consultation with a Senior Steering Group consisting of Government, industry and NGO representatives.
- 2 The Code is intended as a single national standard to guide industry in the design and construction of sustainable homes. It is a means of driving continuous improvement, greater innovation and exemplary achievement in sustainable home building.
- 3 The Code will complement the system of Energy Performance Certificates which was due to be introduced in June 2007 but has been delayed, under the Energy Performance of Buildings Directive (EPBD). The EPBD will require that all new homes (and in due course other homes, when they are sold or leased) have an Energy Performance Certificate providing key information about the energy efficiency/ carbon performance of the home. Energy assessment under the Code will use the same calculation methodology therefore avoiding the need for duplication.
- 4 In the short-term, Code compliance is voluntary but home builders are encouraged to follow Code principles set out in this publication because the Government is considering making assessment under Code standards mandatory in the future. Currently, consultation is taking place on making the Code mandatory. For more information about the consultation visit www.communities.gov.uk/publications/planningandbuilding/futurecodeconsultation

How does the Code work?

- 5 The Code uses a sustainability rating system – indicated by ‘stars’, to communicate the overall sustainability performance of a home. A home can achieve a sustainability rating from one (★) to six (★★★★★★) stars depending on the extent to which it has achieved Code standards. One star (★) is the entry level – above the level of the Building Regulations; and six stars (★★★★★★) is the highest level – reflecting exemplar development in sustainability terms.

- 6 The sustainability rating which a home achieves represents its overall performance across the nine Code design categories (energy/CO₂, water, materials, surface water run-off, waste, pollution, health and well-being, management, and ecology).
- 7 Minimum standards exist for a number of categories – these must be achieved to gain a one star (★) sustainability rating. Energy efficiency and water efficiency categories also have minimum standards that must be achieved at every level of the Code, recognising their importance to the sustainability of any home.
- 8 Apart from these minimum requirements the Code is completely flexible; developers can choose which and how many standards they implement to obtain 'points' under the Code in order to achieve a higher sustainability rating.
- 9 So, in order to achieve a particular code level and the associated sustainability rating, a home must integrate minimum standards, and additional points for other design features must be attained.
- 10 Assessment procedures will be transparent and technically rigorous, whilst at the same time straightforward and beneficial to all parties.
- 11 The method will be similar to BRE's EcoHomes System which depends on a network of specifically trained and accredited independent assessors. BRE will retrain and accredit assessors for the new Code. Code assessors will conduct initial design stage assessments, recommend a sustainability rating, and issue an interim Code certificate. They will perform a post-completion check to verify the rating before a final Code certificate of compliance is issued.
- 12 A design stage assessment will only need to be carried out on each home type within any development – not every single home. Post-completion checks will be carried out on a sample basis.
- 13 Builders whose home designs and completed work are assessed under the Code will receive a certificate showing the overall sustainability rating for the home, and a breakdown of how that rating has been achieved.

Appendix 5: Recycling

Information for Developers of Residential proposals:

1. This information is intended to help and guide developers in providing adequate storage facilities at residential properties to store containers for Refuse, Green Waste and Recycling. It is recommended that all developers contact the City of York Council's Waste Services Department for advice at the planning stage and again before construction begins. It is the responsibility of developers to provide containers and these can be ordered and purchased by ringing 01904 553272 or e-mailing recycling.team@york.gov.uk.
2. Individual properties e.g. detached, semidetached, terraced with gardens or forecourts.

Refuse & Green (garden) waste collection.

- 2.1 City of York Council currently operate an alternate weekly collection of domestic and garden waste to over 60,000 suitable properties. These properties primarily include those with garden space, e.g. detached, semi-detached, town houses with gardens etc. The standard sized refuse and green waste wheeled bin has a capacity of 180 litre.

Table 1. Wheeled bins for Refuse/Green Waste Collections – individual properties

Bin Capacity (litres)	Policy Standard	Width (mm)	Height (mm)	Depth (mm)	Domestic or Green Waste
180	Yes	480	1070	730	both

- 2.3 The wheeled bins will be collected from the edge of each property at the front. The Refuse Collectors will not enter onto private land to make a collection. Consideration must therefore be given to the fact that the residents will be required to wheel their bins to the front and leave on the edge of their properties for collection as well as adequate space for pedestrians with prams/wheel-chairs to pass safely.

Kerbside recycling.

- 2.4 The City of York Council currently empty boxes and bags from each property on the scheme every fortnight on the same day as refuse collection though on the alternate week. Residents are asked to put paper and cardboard into bags and glass bottles and jars, plastic bottles and food and drink cans in the 55 litre box. Collections are from the front of the property.

Figure 1. Kerbside Recycling Box Dimensions

- 2.5 Figure 1 indicates the dimensions of the Kerbside Recycling boxes. The box can be kept outside if necessary and the bag can be kept on top of or inside the box.

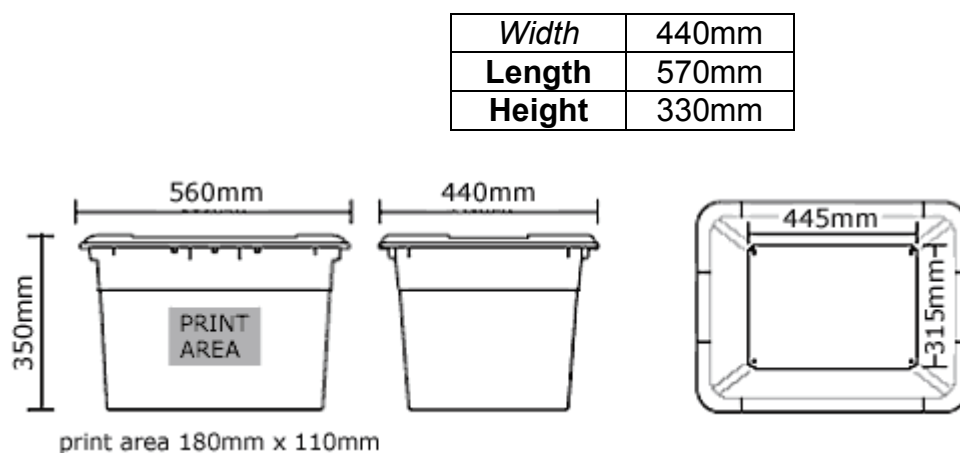

3. Communal Properties i.e. flats

- 3.1 In the past these types of property have been difficult to collect waste and recycling from. Adequate space needs to be provided for temporary storage of waste and recycling outside the property and possibly also inside in communal areas. There are a number of options available as to how this can be achieved and the options, or combination of options, will depend on the size, layout and servicing/management arrangements for the proposal. Which ever is chosen it must enable the collection of paper and cardboard in bags and glass bottles and jars, plastic bottles and food, drink cans in a box.
- 3.2 The City of York Council can provide several different sized containers for communal properties residual waste. See Table 2. N.B. 360 litre containers are usually only used for 2 properties sharing a container.

Table 2. Wheeled bins for Refuse Collections – communal properties

Bin Capacity (litres)	Width (mm)	Height (mm) (Lid closed)	Depth (mm)
360	620	1100	860
660	1360	1170	770
1100	1200	1360	915

240 & 360 Style Container

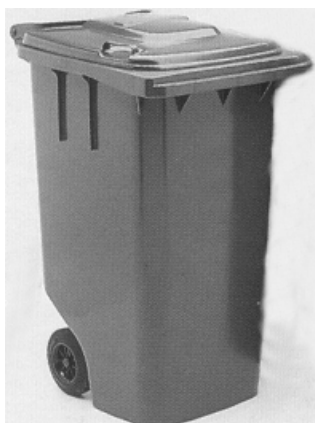

1100 & 660 Style container



- 3.3 Developers should ensure that adequate provision is made to store an adequate number of containers, based on the dimensions in table 2 and figure 1 on communal properties.
- 3.4 The Refuse Collectors can enter onto a communal property to access a bin store in order to collect the refuse where reasonably possible. Consideration should be given to allow the collection vehicle enough room to gain access to the bin store. Table 3 details the dimensions of an average sized RCV.

Table 3. Dimensions of an average refuse collection vehicle.

Dimensions	Refuse Vehicle	Recycling Vehicle
Height	3.39 m	6.00m
Width	3.00 m	3.00 m
Length	11.00 m	11.00 m
Vehicle Weight	Up to 26 tonnes	Up to 26 tonnes
Turning Circle (kerb to kerb) *	21.50m	22.50m
Location of work area	Rear	Side

* For wall to wall add 1600mm.

- 3.5 Bin stores for communal properties should be located as near to the road as possible with a flat even surface between the stores and the vehicle collection point, (NB not gravel, cobbles etc.) to reduce the distance the refuse collectors have to travel to empty the bins and a site visit may be made to determine suitability.
- 3.6 If it is not possible to get a Collection Vehicle next to the bin storage area the Refuse Collectors will only enter onto the property to collect the refuse if the bins are within a reasonable walking distance, up to a maximum of 20 metres, for collection. City of York Council will not hold any keys to bin stores so access must be available for our staff on collection days.
- 3.7 Collections are made from the boundary, at the front of the property, in the same location as the refuse bin. The Collection Operatives will not enter onto private land to make a collection.

4. Costs

Refuse and Kerbside Recycling Collections

- 4.1 Containers for both the Refuse and Kerbside Recycling Collections should be purchased by the developer preferably via the City of York Council York Customer Centre Section as per City of York Council policy. Table 4 gives indicative prices for the costs of the containers:

Table 4. Indicative costs of Refuse and Kerbside Recycling containers

Container	Price (incl. delivery)
Box & set of Bags	£4.99 + VAT
180 litre wheeled bin	£26.30 + VAT
360 litre wheeled bin	£49.50 + VAT
660 litre wheeled bin	£249.00 +VAT
1100 litre wheeled bin	£285.00 + VAT

Correct as at September 2007 and subject to change.

Recycling Banks

- 4.2 It is recommended that all new developments include an area that can be used to site recycling banks. Other local authorities have found that there is still a need for recycling banks in addition to Kerbside Recycling collections. These banks tend to be used by residents whose property is not suitable for a Kerbside Recycling collection, for materials that cannot be collected through the Kerbside Collections or used by residents who collect surplus materials that they wish to recycle before the next collection day.
- 4.3 The area should be within walking distance to the residential properties but not so close that those living in close proximity to the banks are disturbed by noise. It may be necessary to consult residents living in close proximity to the recycling banks.
- 4.4 The number and size of containers can vary from site to site depending upon local requirements. It is recommended that a minimum area of approximately 8m x 4m is required to site a standard range of paper, glass and can banks.
- 4.5 Consideration should be given to vehicle access which is required to empty the containers. The design of the site of the site should also be considered as it will require hard standing and may need screening from nearby properties if appropriate.
- 4.6 Developers may be required to pay for any recycling banks required. Depending upon the circumstances a contribution may also be required from the Developers towards the costs of emptying the banks for a certain period.

5. Home Composting

5.1 To assist residents to reduce the amount of residual waste they put out for collection it is recommended that a home compost bin is provided to each property with a garden. The council works in partnership with the government's 'Waste Resource Action Plan' (WRAP) to promote home composting and provide home compost bins to residents in York and North Yorkshire at discounted prices. The council may be able to assist the developer purchase compost bins through this partnership.

5.2 For further assistance and advice please contact the recycling team on:

Tel:- 01904 553272,
email: recycling.team@york.gov.uk
write:- City of York Council
Waste Services
Eco Depot
Hazel Court
York
YO10 3DQ.